

## Technical Data Sheet

Tray

Gilboa 40

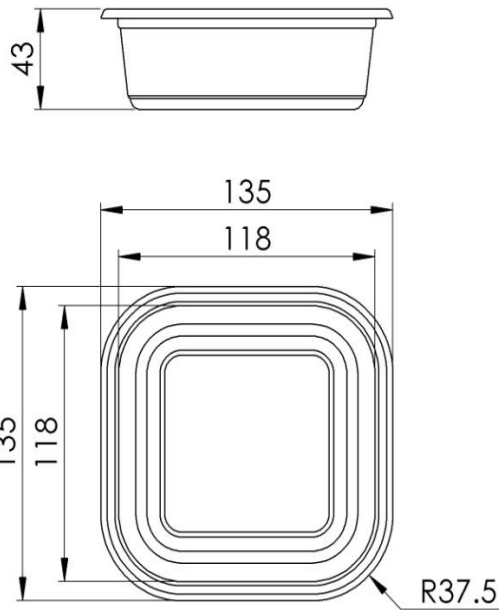

### Packaging specifications

Type of pallet	Wood
Units per package	1056
Package per pallet	12
Total units per pallet	12672

**Food contact approval** In compliance with the EU 10/2011, Israel standard 5113, CFR 21 USA-FDA

\* The given tech. data are Typical values only.

\* It is the customer responsibility to check the suitability of the product to his production process.